

Panasonic®

IC Recorder
RR-QR240
RR-QR80

Operating Instructions

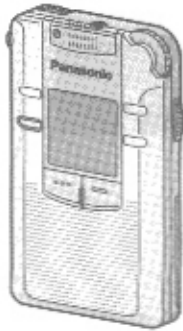

Before connecting, operating or adjusting this product, please read these instructions completely. Please keep this manual for future reference.

The RR-QR240 model is only for the U.S.A.

P PC

Panasonic Consumer Electronics Company, Division of
Matsushita Electric Corporation of America
One Panasonic Way Secaucus, New Jersey 07094
<http://www.panasonic.com>

En

Panasonic Sales Company, Division of Matsushita Electric of
Puerto Rico, Inc. ("PSC")
Ave. 65 de Infantería, Km. 9.5 San Gabriel Industrial Park, Carolina,
Puerto Rico 00985

Panasonic Canada Inc.
5770 Ambler Drive, Mississauga, Ontario L4W 2T3
www.panasonic.ca

ROT5133-P
F0699KY0 (D)

Inserting the batteries

Long life alkaline batteries are recommended.
If rechargeable batteries are to be used, rechargeable batteries manufactured by Panasonic are recommended.

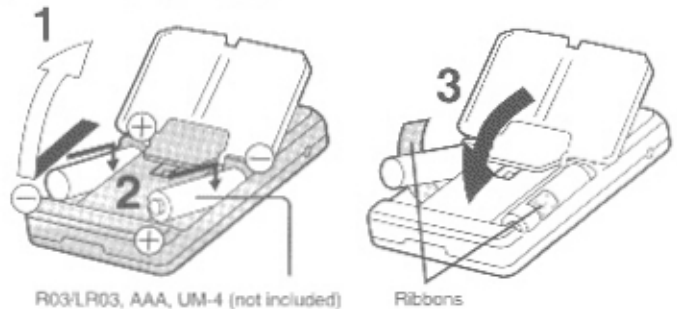

R03/LR03, AAA, UM-4 (not included)

Ribbons

Note

- Lay the ribbons under the batteries to make removal easier.
- Be sure the ribbons do not stick out when the lid is closed.

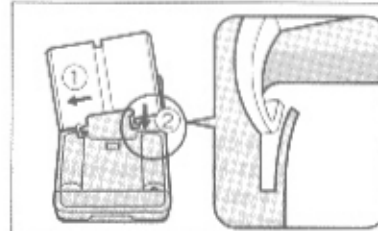

If the battery cover comes loose:

Push the cover's levers into the cutouts in the compartment as shown in the illustration.

After the batteries are inserted:

If the year starts flashing on the display, set the time so the unit can keep track of the time and date of recordings. For details see "Setting the time" (page 3).



Note

Do not press the buttons while inserting the batteries. This may cause malfunction of the unit or its display.

Features

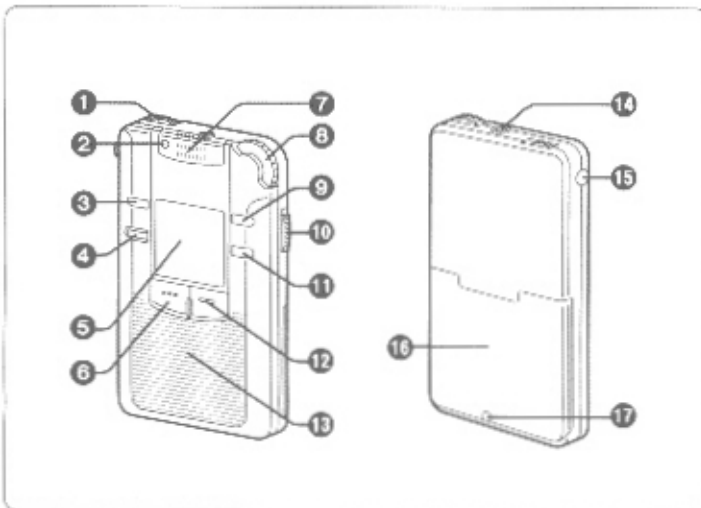

- 1 Volume control (VOL)
- 2 Recording lamp
- 3 Divide button (DIVIDE)
- 4 Erase button (ERASE)
- 5 Display screen
- 6 Stop button (STOP)
- 7 Microphone (MIC)
- 8 Play/stop, select dial (PLAY/STOP SEL)
- 9 Mode button (MODE)

- 10 Hold switch (HOLD)
- 11 Folder button (FOLDER)
- 12 Recording, pause button (•REC, = PAUSE)
- 13 Speaker
- 14 Microphone jack (MIC)
- 15 Earphone jack (?)
- 16 Battery cover
- 17 Hand strap hole

The battery indicator

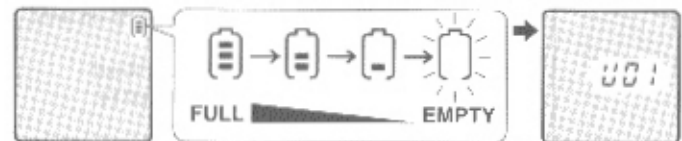

Replace the batteries.

Note

- The battery indicator is not shown while the recorder is stopped.
- This unit indicates that the batteries have run down when there is actually still some life left in them. This is to preserve the contents of the memory.
- Replace the batteries within 30 seconds or settings revert to how they were at the time of purchase. Recordings remain intact.
- The unit does not work correctly if the battery cover is not closed completely.

Hold function

This function prevents accidental operation.

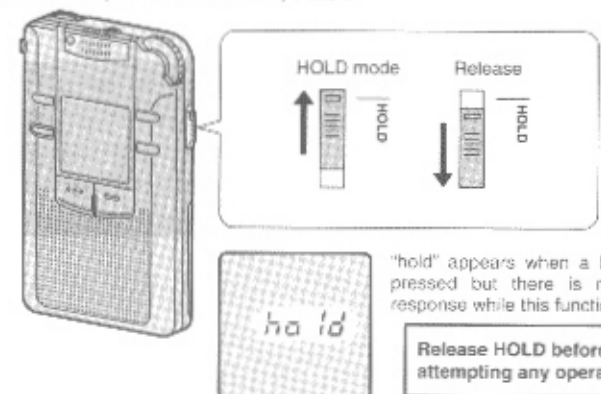

Setting the time

Set the time after inserting the batteries so the times for the recordings are saved.

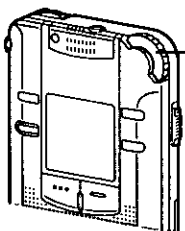

1 SELECT
Within 10 seconds, turn [PLAY/STOP SEL] to choose the item.

2 SET
Within 10 seconds, press [PLAY/STOP SEL] to select the item.

Repeat 1 and 2 to complete the settings.

① SELECT the year → **② SELECT** the month → **③ SELECT** the day

④ SELECT 12 or 24 hour time display → **⑤ SELECT** the time

Normal display

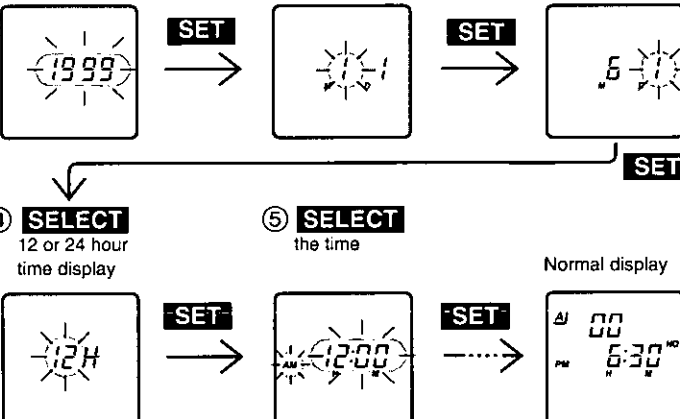

Correcting the time settings

Press [MODE] to display the setting you want to correct, then [SELECT] and [SET] to change it.

Changing modes

Each time [MODE] is pressed, the modes change in the following order.

- LOCK (see page 8)* ←
- Recording mode (see page 5)
- Microphone sensitivity (see page 5)
- Voice activated system (see page 5)
- Playback speed (see page 6)
- BEEP (see page 11)
- Timer recording (see pages 9 and 10)
- Timer playback (see pages 9 and 10)*
- Time (see page 3)

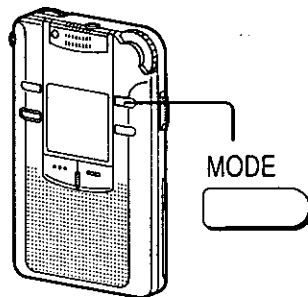

*Not displayed if there are no recordings.

Note

- The original display is restored if an operation isn't performed within 10 seconds.
- Settings can be canceled by pressing [STOP].

Recording

Items can be stored in separate "folders". Each folder can hold up to 99 items. Total recording time depends on the model and recording mode (see page 5, "Changing recording mode").

	Recording mode	Model	
		RR-QR240	RR-QR80
Available recording time	LP (Long play)	266 minutes	60 minutes
	SP (Standard play)	133 minutes	30 minutes
	HQ (High quality)	66 minutes	15 minutes
Folders		4 (A,B,C,D)	2(A,B)

Note

- Total recording time is the combined time of all the folders.
- The recording mode is originally set to "HQ".
- The recording being made can be lost if the unit receives a shock (e.g. it is dropped), or if the batteries and cover come loose.
- Leave VAS (page 5) off when recording important items.

1 Press [FOLDER] to select the folder to record into.

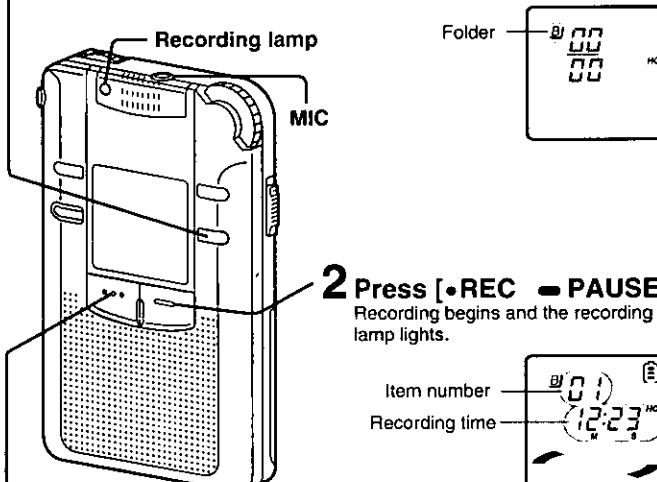

2 Press [•REC = PAUSE]. Recording begins and the recording lamp lights.

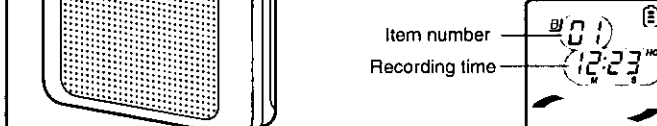

3 Press [STOP]. Recording stops. The display changes in the following order:

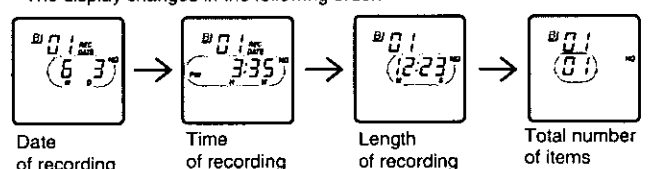

To pause recording:
Press and hold [•REC = PAUSE]. The recording lamp flashes. Press again to resume recording.

To record through the external microphone:
Plug the external microphone (not included) into the [MIC] jack. Then follow the steps 1-3 as illustrated above. You can use a condenser microphone with or without built-in power supply. Plug type: 3.5 mm (1/8 in.) monaural

To check available recording time:
Press [MODE] while recording. Press again to restore the display.

This display also appears when there is about 10% of the total recording time left. Press [MODE] to show the normal recording display for about 3 seconds.

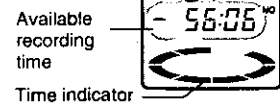

e.g. Display for RR-QR240

Time indicator:

The sections disappear clockwise to indicate remaining recording time. The last section flashes when about 10% of the total recording time is left.

When "FULL" is displayed:

There is no available time or there are no available item numbers to record into. To continue recording, erase unneeded items.

■ Changing recording mode

Three modes can be selected. The mode is originally set to HQ ("HI").

- 1 Press [MODE] several times until the recording mode display is displayed.

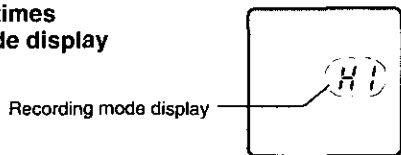

- 2 Within 10 seconds, turn [PLAY/STOP SEL] to select the required mode.

Recording mode changes the total recording time.

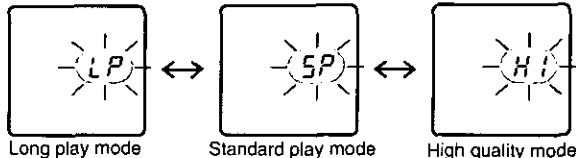

- 3 Within 10 seconds, press [PLAY/STOP SEL].
The mode is selected.

Note

"HQ" lights in other displays to indicate you have selected high quality mode.

■ Preventing unnecessary recording (Voice activated system: VAS)

VAS detects silence and pauses recording automatically. The lower the microphone sensitivity (see "Changing microphone sensitivity"), the better this function works. The voice mark flashes while VAS is waiting for a sound to record.

- 1 Press [MODE] several times until the voice mark is displayed.

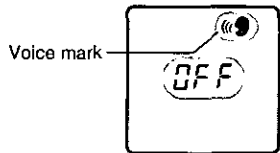

- 2 Within 10 seconds, turn [PLAY/STOP SEL] to select "On".

- 3 Within 10 seconds, press [PLAY/STOP SEL].
VAS is now on.

To turn the function off:

Select "OFF" in step 2 and press [PLAY/STOP SEL].

■ Changing microphone sensitivity

Two levels of microphone sensitivity can be selected. The level is originally set to "H".

- 1 Press [MODE] several times until the microphone sensitivity display is displayed.

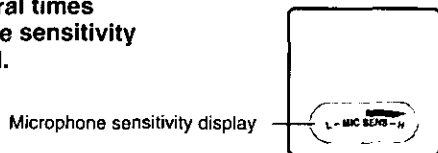

- 2 Within 10 seconds, turn [PLAY/STOP SEL] to select the required level of sensitivity.

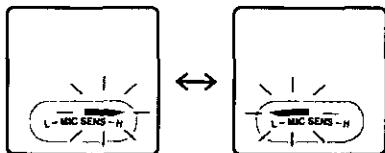

High: Relatively soft sounds are recorded.

Low: Only relatively louder sounds are recorded. Use when recording close to the mouth.

- 3 Within 10 seconds, press [PLAY/STOP SEL].
The level is selected.

Note

Microphone sensitivity is shown only when sensitivity level is being changed. It is not shown constantly.

Playback

- 1 Press [FOLDER] to select the folder containing the item you want to play.

Earphone jack ?

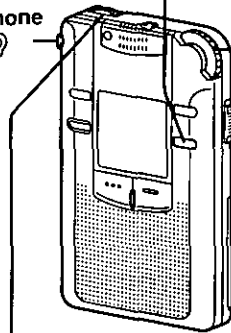

- 2 Turn [PLAY/STOP SEL] to select the item you want to play.

Information about the selected item appears in the following order:

- ① Date of recording
- ② Time of recording
- ③ Length of recording
- ④ Number of items
- ⑤ Normal display

- 3 Press [PLAY/STOP SEL].

Playback starts.

- 4 Adjust the volume.

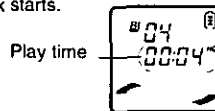

Other methods of playback

Use [PLAY/STOP SEL].

To stop playback		Press during play. Press again to resume playback.
To move to other items during play		Turn slowly. Return to the beginning of the item by turning backward. Turn again within 3 seconds to move to the previous item.
Cue and review		Turn quickly during play. You can cue and review within an item only.

■ To check the remaining playback time:

Press [MODE] during play.

Press again to restore the display.

Time indicator:

The sections disappear clockwise to indicate remaining playback time.

Remaining playback time

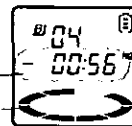

■ To listen to the first few seconds of each item (Intro-scan)

Press and hold [PLAY/STOP SEL] while stopped for a moment.

The first 5 seconds of each item are played, in order, beginning with the first item. If you want to listen to an item in full, press [PLAY/STOP SEL] while it is playing.

■ To change playback speed

Three playback speeds can be selected. The speed is originally set to normal.

- 1 Press [MODE] several times until the playback speed display is displayed.



- 2 Within 10 seconds, turn [PLAY/STOP SEL] to select the speed.

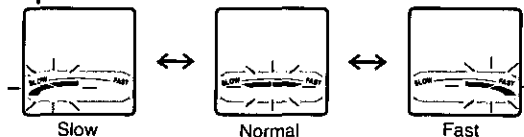

- 3 Within 10 seconds, press [PLAY/STOP SEL].
The speed is selected.

For your reference

Press and hold [STOP] after the normal display is restored to restore normal playback speed.

■ Using earphone (not included)

Use a monaural type if you want to listen with an earphone.

Insert the earphone plug into the earphone jack. (Plug in firmly.)

Sound will not be heard from the speaker.

Plug type: 3.5 mm (1/8 in.) monaural

Note

Volume may be changed after cueing, reviewing, stopping and dividing items.

Dividing items

You can divide an item into two at a point you choose. This allows you to extract the important parts of a recording to save.

Preparation:

Select the folder and the item you want to divide.
(page 6, step1-2)

1 Press [PLAY/STOP SEL] to start playback of the item.

2 Press [DIVIDE] at the point you want to divide the item.
The number of the item flashes.

3 Within 10 seconds, press and hold [DIVIDE].
The item is divided.

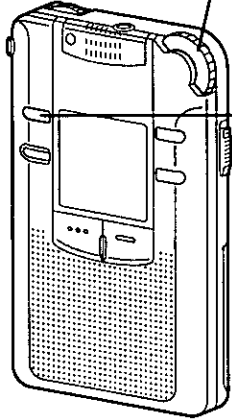

Item number after division

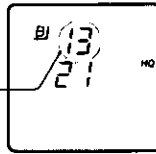

The item numbers after the divided item increase by one. Play is ready to start from the beginning of the latter of the two items created by this operation.

Note

- You cannot divide an item if a folder already has 99 items.
- You may not be able to divide recordings less than one second.
- There may be a slight difference between the recording start time display for the items after division and the actual recording start time. The recording start time is intended to serve as a general guide only.
- The total time may not agree with the original recording time if an item is divided into many different items.

Moving items

You can move an item to a different folder. This allows you to categorize items and save them together.

Preparation:

Select the folder and the item you want to move.
(page 6, step1-2)

1 Press [PLAY/STOP SEL] to start playback of the item.

2 Press [FOLDER] to select the folder you want to move the item to.

Present folder

New folder

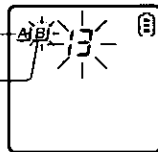

3 Within 10 seconds, press [PLAY/STOP SEL].
The item moves to the end of the selected folder.

Erasing items

Items can either be erased one by one or all at once. ERASE mode cannot be selected while an empty folder is selected. Erased items cannot be recalled.

Preparation:

Select the folder first to erase individual items or folders.
(page 6, step1)

1 Press and hold [ERASE] while stopped or during play.

2 Within 10 seconds, turn [PLAY/STOP SEL] to select the item you want to erase.
The display changes in the following order:

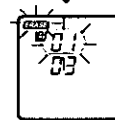

The first item in the folder

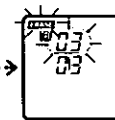

The last item in the folder

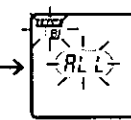

All items in the folder

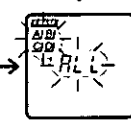

All folders*

3 Within 10 seconds, press [ERASE].

The selected item is erased.

*Only "A" and "B" are shown on the RR-QR80 (see page 4).

Note

- Locked items will not be erased (see below).
- Total recording time can be reduced after erasing a number of items. Remedy this by erasing all the folders occasionally.

Erasure prevention

Lock individual recordings to avoid accidentally erasing them.

Preparation:

Select the folder containing the item you want to lock.
(page 6, step1)

1 Press [MODE] until "LOCK" flashes.

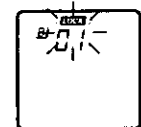

2 Within 10 seconds, turn [PLAY/STOP SEL] to select the item.

3 Within 10 seconds, press [PLAY/STOP SEL].
The item is locked and "LOCK" is displayed until canceled.

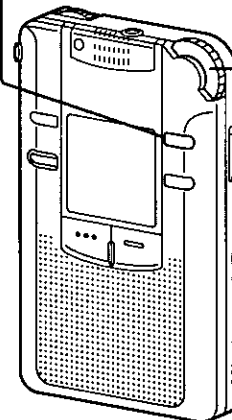

To unlock:

- 1 Select the locked item.
- 2 Repeat steps 1 and 3 for each item.

Timer recording and playback

■Timer recording

Recording can be set to start and finish at set times. You must set the current time (see page 3).

Preparation:

Select the folder to record into. (page 6, step 1)

- 1 Press [MODE] several times until the timer recording display is displayed.

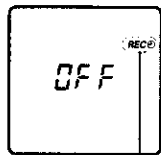

Timer recording display

- 2 Within 10 seconds, turn [PLAY/STOP SEL] to select "On".

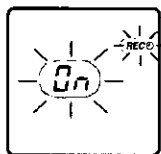

3 Set the times.

- 1 Within 10 seconds, press [PLAY/STOP SEL]. The start time flashes.
- 2 Within 10 seconds, turn [PLAY/STOP SEL] to change the start time.

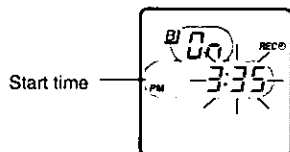

Start time

- 3 Within 10 seconds, press [PLAY/STOP SEL]. The start time is set and the finish time flashes.
- 4 Within 10 seconds, turn [PLAY/STOP SEL] to change the finish time. The item moves to the end of the selected folder.

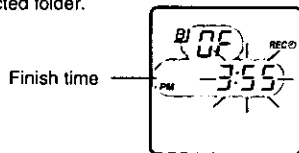

Finish time

- 5 Within 10 seconds, press [PLAY/STOP SEL]. The display changes in the following order indicating completion of the settings.
Recording start time → Recording finish time → Timer on indicator

■Timer playback

Playback can be set to start at set time. You must set the current time (see page 3).
Timer playback cannot be selected while an empty folder is selected.

Preparation:

Select the folder and the item you want to play. (page 6, step 1-2)

- 1 Press [MODE] several times until the timer play display is displayed.

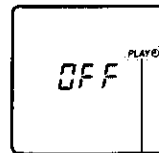

Timer play display

- 2 Within 10 seconds, turn [PLAY/STOP SEL] to select "On".

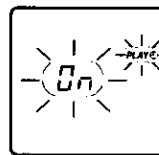

3 Set the times.

- 1 Within 10 seconds, press [PLAY/STOP SEL]. The start time flashes.
- 2 Within 10 seconds, turn [PLAY/STOP SEL] to change the start time.

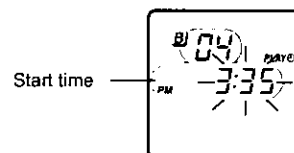

Start time

- 3 Within 10 seconds, press [PLAY/STOP SEL]. The start time is set.
The display changes in the following order indicating completion of the settings.
Playback start time → Timer on indicator

The timer playback stops automatically.

The timer recording display and the timer playback display flash while the timer is operating.

To cancel the timer:

Select "OFF" in step 2 and press [PLAY/STOP SEL].

To check the timer settings:

Press [mode] several times until the timer display is displayed. The display will then change to show the following automatically.

Timer recording: Start time, finish time, folder the item will enter.

Timer playback: Start time, folder and item to be played.

Note

- The two timers cannot be used together. The timer set last is activated.
- The timers can only be set within a single twenty-four hour period. The recording timer can only be set if there is one minute or more of available recording time.
- If you make recordings before timer recording begins, be aware that the time available is reduced. The timer recording can only continue as long as the available time allows.
- If VAS is left on during timer recording, the recording may be shorter than the set time.
- The timer settings are canceled if the clock is cleared (page 2).

The operating tone

The operation tone can be turned on and off. The tone is originally set to "On".

- 1 Press [MODE] several times until "bEEP" is displayed.



- 2 Turn [PLAY/STOP SEL] to select "On" or "OFF".

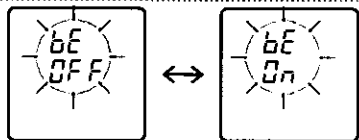

- 3 Within 10 seconds, press [PLAY/STOP SEL].
A tone sounds each time an operation is performed if you select "On".

Care and Use

Unit

- Avoid using or placing this unit near sources of heat. Do not leave it in an automobile exposed to direct sunlight for a long period of time with the doors and windows closed.
- To avoid product damage, do not expose this product to rain, water or other liquids.
- Do not apply heat to batteries, or internal short circuit may occur.
- If this unit is not to be used for a long period of time, remove the batteries and store them in a cool and dry place.
- Remove spent batteries immediately.

Dry cell battery

- Load the new batteries with their polarities (+ and -) aligned correctly.
- Do not apply heat to batteries, or internal short circuit may occur.
- If this unit is not to be used for a long period of time, remove the batteries and store them in a cool and dry place.
- Remove spent batteries immediately.

Listening caution



Do not play your headphones or earphone at a high volume. Hearing experts advise against continuous extended play.

If you experience a ringing in your ears, reduce volume or discontinue use. Do not use while operating a motorized vehicle. It may create a traffic hazard and is illegal in many areas.

You should use extreme caution or temporarily discontinue use in potentially hazardous situations.

Even if your headphones or earphone is an open-air type designed to let you hear outside sounds, don't turn up the volume so high that you can't hear what's around you.

Sound can be deceiving. Over time your hearing "comfort level" adapts to higher volumes of sound. So what sounds "normal" can actually be loud and harmful to your hearing. Guard against this by setting your equipment at a safe level BEFORE your hearing adapts.

To establish a safe level:

- Start your volume control at a low setting.
- Slowly increase the sound until you can hear it comfortably and clearly, and without distortion.
- Once you have established a comfortable sound level:
- Set the dial and leave it there.

Product Service

Do not attempt to remove the cover(s) or repair the unit yourself. Refer servicing to qualified personnel only.

Product information

For product service, product information or assistance with product operation, refer to the servicenter directory.

User memo:

DATE OF PURCHASE _____
DEALER NAME _____
DEALER ADDRESS _____
TELEPHONE NUMBER _____

The serial number of this product can be found inside of the battery compartment. Please note them in the space provided below and keep as a permanent record of your purchase to aid identification in the event of theft.

MODEL NUMBER _____

SERIAL NUMBER _____

Maintenance

Clean with a soft cloth. For very dirty surfaces clean with a mild dish washing liquid, then wipe with a dry cloth. Do not use alcohol or thinners to clean this unit.

Troubleshooting Guide

Before requesting service for this unit, check the chart below for a possible cause of the problem you are experiencing. Some simple checks or a minor adjustment on your part may eliminate the problem and restore proper operation.

If you are in doubt about some of the check points, or if the remedies indicated in the chart do not solve the problem, refer to the directory of Authorized Service Centers (enclosed with this unit) to locate a convenient service center, or consult your dealer for instructions.

For detailed instructions, contact an authorized servicenter in the U.S.A. and Panasonic Canada Inc. Customer Care Centre in Canada.

In the U.S.A. 1-800-211-7262 or web site (<http://www.panasonic.com>)
In Canada 905-624-5505 or web site (www.panasonic.ca/faq.html)

Symptom	Checkpoints
Unit doesn't operate	<ul style="list-style-type: none"> • Is HOLD on? (page 2) • Is the the battery cover properly closed?
No sound from the speaker	<ul style="list-style-type: none"> • Is earphone (not included) connected? • Is the volume turned down?
When using earphone (not included), there is no sound or it is difficult to hear or there is noise	<ul style="list-style-type: none"> • Is the earphone plug fully inserted? • Is the plug dirty? (Wipe away dirt on plug.)
"U01" appears on the display	<ul style="list-style-type: none"> • Have the batteries run down?
Recording stops	<ul style="list-style-type: none"> • Has VAS (page 5) functioned?
Recording not made	<ul style="list-style-type: none"> • Did the batteries or cover come loose during recording?
The date of recording appears as "---"	<ul style="list-style-type: none"> • Has the time been set? (The date of recording is not displayed unless the time has been set.)
Playback speed is too fast or slow	<ul style="list-style-type: none"> • Has playback speed been changed? (See page 6 to set to the required speed.)
"FULL" appears when trying to make a recording	<ul style="list-style-type: none"> • Have 99 items been recorded in the folder? • Has the recording time limit been made? (page 4)
Cannot erase a folder or item	<ul style="list-style-type: none"> • Have you selected an empty folder? • Is the item locked? (page 8)
The clock flashes "12:00"	<ul style="list-style-type: none"> • Set the clock. (page 3)

Specifications

Power requirement:	DC 3 V (two R03/LR03, AAA, UM-4 batteries)
Power output:	110 mW (max.)
Frequency response:	450 Hz - 5.0 kHz (- 6 dB, Extra Mic in - HP out, HQ mode)
S/N:	37 dB (Built-in Mic, HQ mode)
Jack:	
Output jack;	Earphone, 3.5 mm (1/8 in.); 200 mV 16 Ω
Input jack;	Mic, 3.5mm (1/8 in.); 0.56 mV
Speaker:	2.8 cm (1 1/2 in.) 8 Ω
Dimensions (W×H×D):	
Max dimensions;	56.0 × 91.7 × 13.3 mm (2 1/8 × 3 5/8 × 1/2 in.)
Cabinet dimensions;	55.0 × 91.0 × 12.4 mm (2 1/8 × 3 5/8 × 1/2 in.)
Weight:	
with batteries;	About 66 g (2.3 oz.)
without batteries;	About 47 g (1.7 oz.)

Battery life:

[When used at 25°C (77°F) and on a flat and stable surface]

Batteries	Playback	Recording
Panasonic alkaline batteries	About 15 hours	About 30 hours

- The battery life may be less depending on the operating conditions.

Note:

- Specifications are subject to change without notice.
- Weight and dimensions are approximate.

CAUTION:

This equipment has been tested and found to comply with the limits for a Class B digital device, pursuant to Part 15 of the FCC Rules. These limits are designed to provide reasonable protection against harmful interference in a residential installation. This equipment generates, uses and can radiate radio frequency energy and, if not installed and used in accordance with the instructions, may cause harmful interference to radio communications. However, there is no guarantee that interference will not occur in a particular installation. If this equipment does cause harmful interference to radio or television reception, which can be determined by turning the equipment off and on, the user is encouraged to try to correct the interference by one of the following measures:

- Reorient or relocate the receiving antenna.
- Increase the separation between the equipment and receiver.
- Connect the equipment into an outlet on a circuit different from that to which the receiver is connected.
- Consult the dealer or an experienced radio/TV technician for help.

Any unauthorized changes or modifications to this equipment would void the user's authority to operate this device.

This device complies with Part 15 of the FCC Rules. Operation is subject to the following two conditions: (1) This device may not cause harmful interference, and (2) this device must accept any interference received, including interference that may cause undesired operation.

Panasonic Consumer Electronics Company, Division of Matsushita Electric Corporation of America
One Panasonic Way,
Secaucus, New Jersey 07094

ONLY FOR U.S.A.

Panasonic Sales Company, Division of Matsushita Electric of Puerto Rico, Inc. ("PSC")
Ave. 65 de Infierneta, Km. 9.5
San Gabriel Industrial Park
Carolina, Puerto Rico 00985

**Panasonic Audio Products
Limited Warranty**

Panasonic Consumer Electronics Company or Panasonic Sales Company (collectively referred to as "The warrantor") will repair this product with new or refurbished parts, free of charge, in the U.S.A. or Puerto Rico from the date of original purchase in the event of a defect in materials or workmanship as follows:

AUDIO COMPONENTS, RADIOS, COMPACT DISC PLAYERS, VIDEO CD PLAYERS AND HOME ENTERTAINMENT SYSTEMS—For one (1) year.

ACCESSORIES, HEADPHONES AND CARTRIDGES—(when applicable) For ninety (90) days.

BATTERIES—(when applicable)—New rechargeable batteries in exchange for defective rechargeable batteries—For ten (10) days. Non-rechargeable batteries are not warranted.

RECHARGEABLE BATTERY PACKS—(when applicable)—New rechargeable battery packs in exchange for defective rechargeable battery packs for (90) days. Non-rechargeable battery packs are not warranted.

Carry-in or mail-in service in the continental U.S.A. can be obtained during the warranty period from a Panasonic Services Company (PASC) Factory Servicenter listed in the Servicenter Directory. Or call 1-800-211-7262, toll free, to locate an authorized PASC Servicenter. Carry-in or mail-in service in Puerto Rico can be obtained during the warranty period by calling the telephone numbers listed in the Servicenter Directory.

This warranty is extended only to the original purchaser. A purchase receipt or other proof of date of original purchase will be required before warranty service is rendered.

This warranty only covers failures due to defects in materials or workmanship

which occur during normal use and does not cover normal wear to the stylus (when applicable) or dealer installed cartridge or stylus. It does not cover damage which occurs in shipment or failures which are caused by products not supplied by the warrantor or failures which result from accident, misuse, abuse, neglect, mishandling, misapplication, faulty installation, set-up adjustment, improper maintenance, alteration, improper antenna, inadequate signal pick-up, maladjustment of consumer controls, modification, or commercial use of product, or service by anyone other than a PASC Factory Servicenter or authorized PASC Servicenter, or damage that is attributable to acts of God.

LIMITS AND EXCLUSIONS

There are no express warranties except as listed above.
THE WARRANTOR SHALL NOT BE LIABLE FOR INCIDENTAL OR CONSEQUENTIAL DAMAGES RESULTING FROM THE USE OF THIS PRODUCT, OR ARISING OUT OF ANY BREACH OF THIS WARRANTY, INCLUDING WITHOUT LIMITATION, DAMAGE TO TAPES RECORDS OR DISCS. ALL EXPRESS AND IMPLIED WARRANTIES INCLUDING THE WARRANTIES OF MERCHANTABILITY AND FITNESS FOR A PARTICULAR PURPOSE, ARE LIMITED TO THE APPLICABLE WARRANTY PERIOD SET FORTH ABOVE. Some states do not allow the exclusion or limitation of incidental or consequential damages, or limitations on how long an implied warranty lasts, so the above exclusions or limitations may not apply to you.

This warranty gives you specific legal rights and you may also have other rights which vary from state to state.

If a problem with this product develops during or after the warranty period, you may contact your dealer or Servicenter. If the problem is not handled to your satisfaction, then write to the Consumer Affairs Division at the company address indicated above.

If you ship the product

Carefully pack and send it prepaid, adequately insured and preferably in the original carton. Attach a postage-affixed letter, detailing the complaint, to the outside of the carton.

Do NOT send the product to the Executive or Regional Sales offices. They are NOT equipped to make repairs.

Customer's Record

Model No.	Dealer's Name
Serial No.	
or	
Code No.	Dealer's Address
Date of Purchase	

ONLY FOR U.S.A.

*For Product Information, Operating Assistance, Literature Request, Dealer Locations, and all Customer Service inquiries please contact:
800-211-PANA (7262), Monday-Friday 9 am-9 pm Saturday-Sunday 9 am-7 pm, EST.*

*Web Site: <http://WWW.Panasonic.com>
You can purchase parts, accessories or locate your nearest servicer by visiting our Web Site.*

Accessory Purchases:

1-800-332-5368 (Customer Orders Only)
Panasonic Services Company 20421 84th Avenue South, Kent, WA 98032
(6 am to 5 am Monday-Friday; 6 am to 10:30 am Saturday; PST)
(Visa, MasterCard, Discover Card American Express, Check)

Factory Servicenters Locations

CALIFORNIA 6550 Katella Avenue Cypress, CA 90630 800 Dubuque Avenue S. San Francisco CA 94080 20201 Sherman Way Suite 102 Canoga Park, CA 91306 3878 Ruffin Road Suite A San Diego, CA 92123	GEORGIA 8655 Roswell Road Suite 100 Atlanta, GA 30350 ILLINOIS 1703 North Randall Road Elgin, IL 60123 (Pick-up/Drop-off only) 9060 Golf Road Niles, IL 60714	MICHIGAN 37048 Van Dyke Avenue Sterling Heights, MI 48312 MINNESOTA 7850-12 th Avenue South Airport Business Center Bloomington, MN. 55425 OHIO 2236 Waycross Road Civic Center Plaza Forest Park, OH 45240	TENNESSEE 919-8 th Avenue South Nashville, TN 37203 TEXAS 7482 Harwin Drive Houston, TX 77036 13615 Welch Road Suite 101 Farmers Branch, TX 75244
COLORADO 1640 South Abilene Street Suite D Aurora, CO 80012 FLORIDA 3700 North 29 th Avenue Suite 102 Hollywood, FL 33020	MARYLAND 62 Mountain Road Glen Burnie, MD 21061 MASSACHUSETTS 60 Glacier Drive Suite C Westwood, MA 02090	PENNSYLVANIA 2221 Cabot Blvd. West Suite B Langhorne, PA 19047 Chartiers Valley Shopping Center 1025 Washington Pike Bridgeville, PA 15017	WASHINGTON 20425-84 th Avenue South Kent, WA 98032 HAWAII 99-859 Iwaiwa Street Aiea, Hawaii 96701 Phone (808) 488-1996 Fax (808) 486-4369

Service in Puerto Rico

*Matsushita Electric of Puerto Rico, Inc. Panasonic Sales Company/Factory Servicer.
Ave. 65 de Infanteria, Km. 9.5, San Gabriel Industrial Park, Carolina, Puerto Rico 00985
Phone (787) 750-4300 Fax (787) 768-2910*